







EXISTING TREE LEGEND

-  ACER (MAPLE) TREE
-  LAGERSTROEMIA (CRAPE MYRTLE) TREE
-  OLEA (OLIVE) TREE
-  PLATANUS (SYCAMORE) TREE
-  QUERCUS (OAK) TREE
-  SCHINUS (PEPPER) TREE
-  SEQUOIA (REDWOOD) TREE

NOTE: ALL EXISTING TREES SHOWN SHALL REMAIN

SHEET INDEX

- L-1 MASTER SHEET LAYOUT
- L-2 SHEET 'A'
- L-3 SHEET 'B'
- L-4 SHEET 'C'
- L-5 SHEET 'D'
- L-6 SHEET 'E'
- L-7 SHEET 'F'
- L-8 SHEET 'G'
- L-9 SHEET 'H'
- L-10 SHEET 'I'
- L-11 SHEET 'J'
- L-12 SHEET 'K'
- L-13 CITY DETAILS
- L-14 PLANT LEGEND
- L-15 PLANT PHOTOS



MASTER SHEET LAYOUT  
HIDDENBROOKE ENTRY PARKWAY LANDSCAPE CONCEPT MASTER PLAN

SCALE: 1" = 140'-0"

IRRIGATION PLANS WILL COMPLY WITH THE CRITERIA OF THE CITY OF VALLEJO "CHAPTER 16.71 OF THE VALLEJO MUNICIPAL CODE" WATER EFFICIENT ORDINANCE AND WILL APPLY SUCH CRITERIA FOR THE EFFICIENT USE OF WATER IN THE IRRIGATION DESIGN.

*D. Kilian* #2359 MARCH, 2021  
SIGNATURE LICENSE NO. DATE

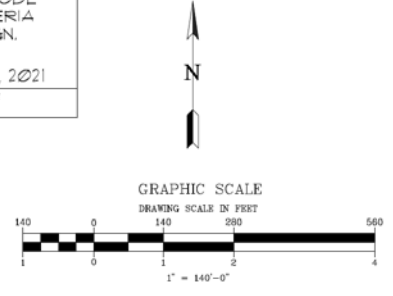

<FILENAME.DWG - FULL ELECTRONIC PATH >

NOTE: THIS IS AN ORIGINAL UNRECORDED WORK AND MAY NOT BE REPRODUCED, COPIED, PUBLISHED, OR OTHERWISE USED WITHOUT THE WRITTEN CONSENT OF BK&A.

DATE	REVISION

BORRECO/KILIAN & ASSOCIATES, INC.  
LANDSCAPE ARCHITECTS  
1241 Pine Street  
Martinez, California 94553  
Phone: 925/372-5306



CITY OF VALLEJO  
WORKING SOURCE - FY 22 / XX >  
HIDDENBROOKE ENTRY PARKWAY  
LANDSCAPE CONCEPT MASTER PLAN

DATE PROJECT # <PROJ. NO. >  
DESIGNED BY B.K.  
DRAWN BY B.K.  
CHECKED BY B.K.  
DATE 03/29/21  
SCALE 1" = 140'-0"  
SHEET 1  
**L-1**  
OF 15 SHEETS  
DRAWING FILE #  
FILE NO.

<DRAWING FILENAME > .DWG





PARKWAY – SHEET 'B'  
 HIDDENBROOKE ENTRY PARKWAY LANDSCAPE CONCEPT MASTER PLAN

SCALE: 1" = 20'-0"

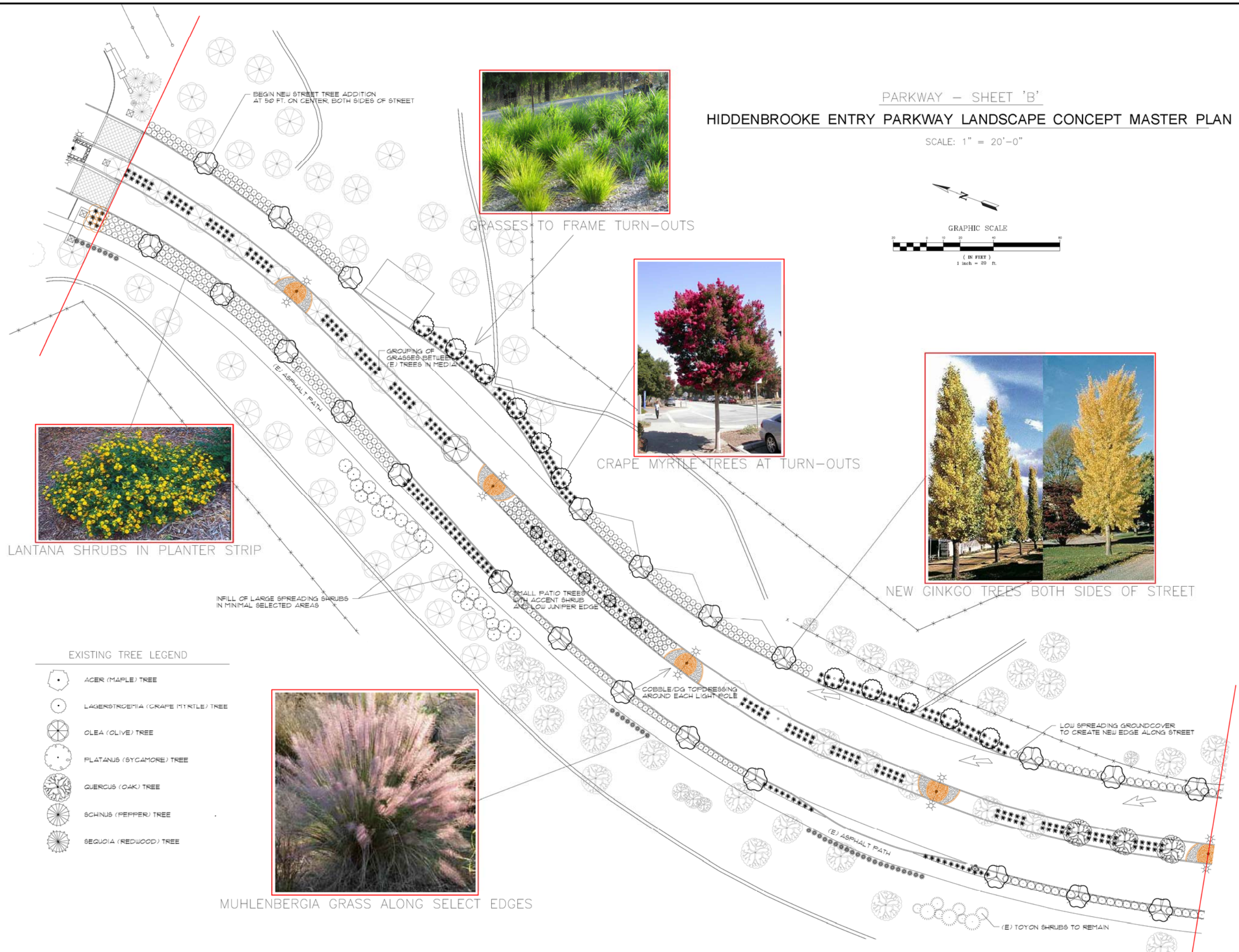
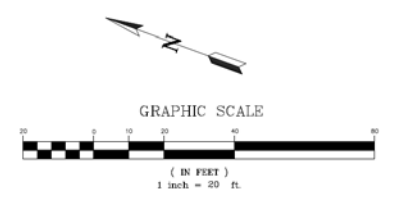

- EXISTING TREE LEGEND
- ACER (MAPLE) TREE
  - LAGERSTROEMIA (CRAPE MYRTLE) TREE
  - OLEA (OLIVE) TREE
  - PLATANUS (SYCAMORE) TREE
  - QUERCUS (OAK) TREE
  - SCHINUS (PEPPER) TREE
  - SEQUOIA (REDWOOD) TREE

NOTE:  
 THIS IS AN ORIGINAL UNRECORDED  
 COPY. IT IS THE PROPERTY OF THE  
 CITY OF VALLEJO. IT IS NOT TO BE  
 REPRODUCED OR TRANSMITTED IN ANY  
 FORM OR BY ANY MEANS, ELECTRONIC  
 OR MECHANICAL, INCLUDING PHOTOCOPYING,  
 RECORDING, OR BY ANY INFORMATION  
 STORAGE AND RETRIEVAL SYSTEM, WITHOUT  
 THE WRITTEN PERMISSION OF THE  
 CITY OF VALLEJO.

NO.	DATE	REVISION

BORRECCO/KILIAN & ASSOCIATES, INC.  
 LANDSCAPE ARCHITECTS  
 1241 Pine Street  
 Martinez, California 94553  
 Phone: 925/372-5306

CITY OF VALLEJO  
 HIDDENBROOKE ENTRY PARKWAY  
 LANDSCAPE CONCEPT MASTER PLAN

CITY PROJECT # < PROJ. NO. >  
 DESIGNED BY B.K.  
 DRAWN BY B.K.  
 CHECKED BY B.K.  
 DATE 03/29/21  
 SCALE 1" = 80'-0"  
 SHEET 1  
 L-3  
 OF 09 SHEETS  
 DRAWING FILE #  
 FILE NO.





COTONEASTER GROUNDCOVER ALONG STREET EDGE



ROW OF VASE SHAPED JUNIPER ALONG STREET EDGE



DOUBLE ROW OF GRASSES BETWEEN SECTIONS OF GROUNDCOVER

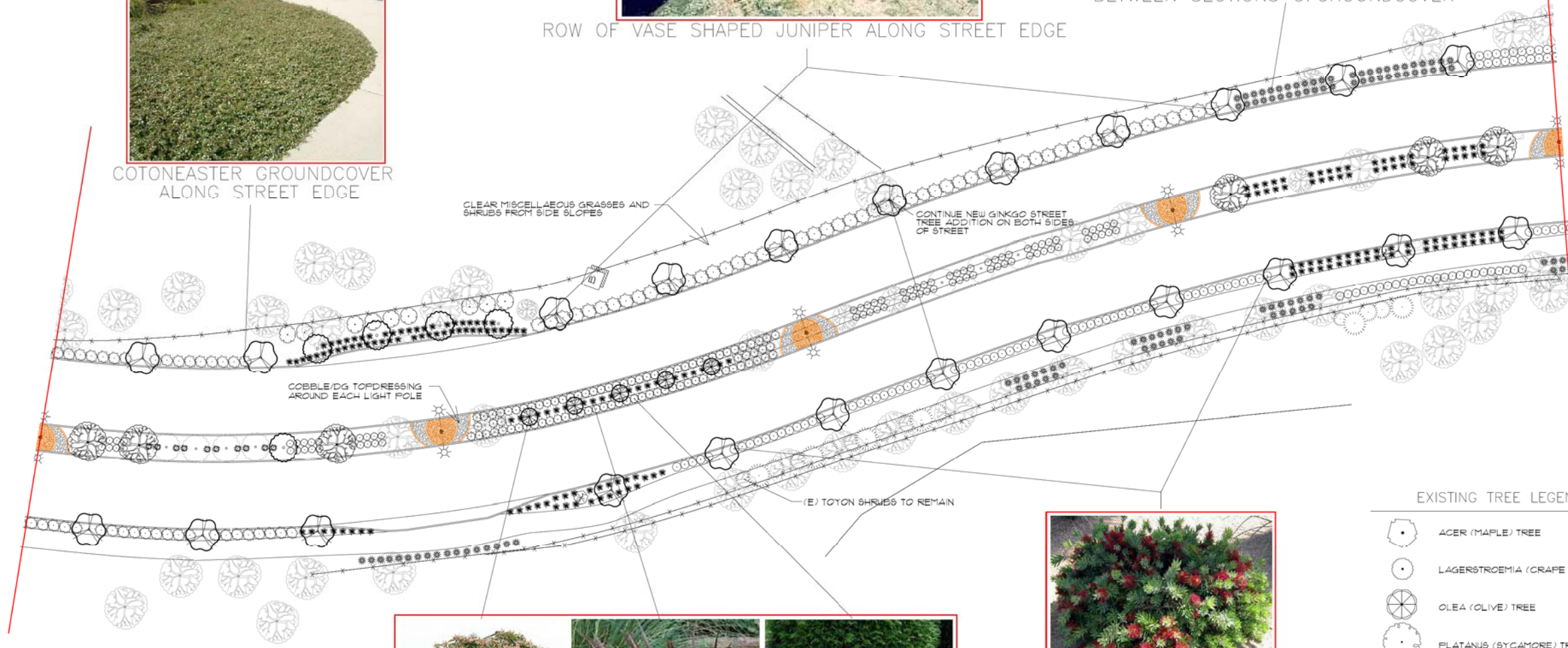

PATIO TREES WITH CONTRASTING COLORED ACCENT SHRUBS AND LOW JUNIPER EDGING IN SELECT MEDIANS



(E) ROW OF 'LITTLE JOHN' TO REMAIN

EXISTING TREE LEGEND

- ACER (MAPLE) TREE
- LAGERSTROEMIA (CRAPE MYRTLE) TREE
- OLEA (OLIVE) TREE
- PLATANUS (SYCAMORE) TREE
- QUERCUS (OAK) TREE
- SCHINUS (PEPPER) TREE
- SEQUOIA (REDWOOD) TREE



PARKWAY - SHEET 'C'  
 HIDDENBROOKE ENTRY PARKWAY LANDSCAPE CONCEPT MASTER PLAN

SCALE: 1" = 20'-0"

NOTE:  
 THIS IS AN ORIGINAL UNRECORDED  
 WORK AND MAY NOT BE REPRODUCED,  
 COPIED, OR TRANSMITTED IN ANY FORM  
 OR BY ANY MEANS, WITHOUT THE WRITTEN CONSENT  
 OF BNA.  
 CONTACT: 626.255.5555

DATE	REVISION



**BORRECO/KILIAN & ASSOCIATES, INC.**  
 LANDSCAPE ARCHITECTS  
 1241 Pine Street  
 Martinez, California 94553  
 Phone: 925/372-5906



CITY OF VALLEJO  
 HIDDENBROOKE ENTRY PARKWAY  
 FUNDING SOURCE - FY 22 / FY 23  
**HIDDENBROOKE ENTRY PARKWAY**  
 LANDSCAPE CONCEPT MASTER PLAN

CITY PROJECT #  
 < PROJ. NO. >  
 DESIGNED BY  
 B.K.  
 DRAWN BY  
 B.K.  
 CHECKED BY  
 B.K.  
 DATE  
 03/29/21  
 SCALE  
 1" = 20'-0"  
 SHEET 1  
**L-4**  
 OF 09 SHEETS  
 DRAWING FILE #  
 FILE NO.

FILENAME.DWG - FULL ELECTRONIC PATH

DRAWING FILENAME > DWG





CONTINUATION OF GINKGO STREET TREES BOTH SIDES OF STREET



LANTANA GROUNDCOVER ALONG STREET EDGE

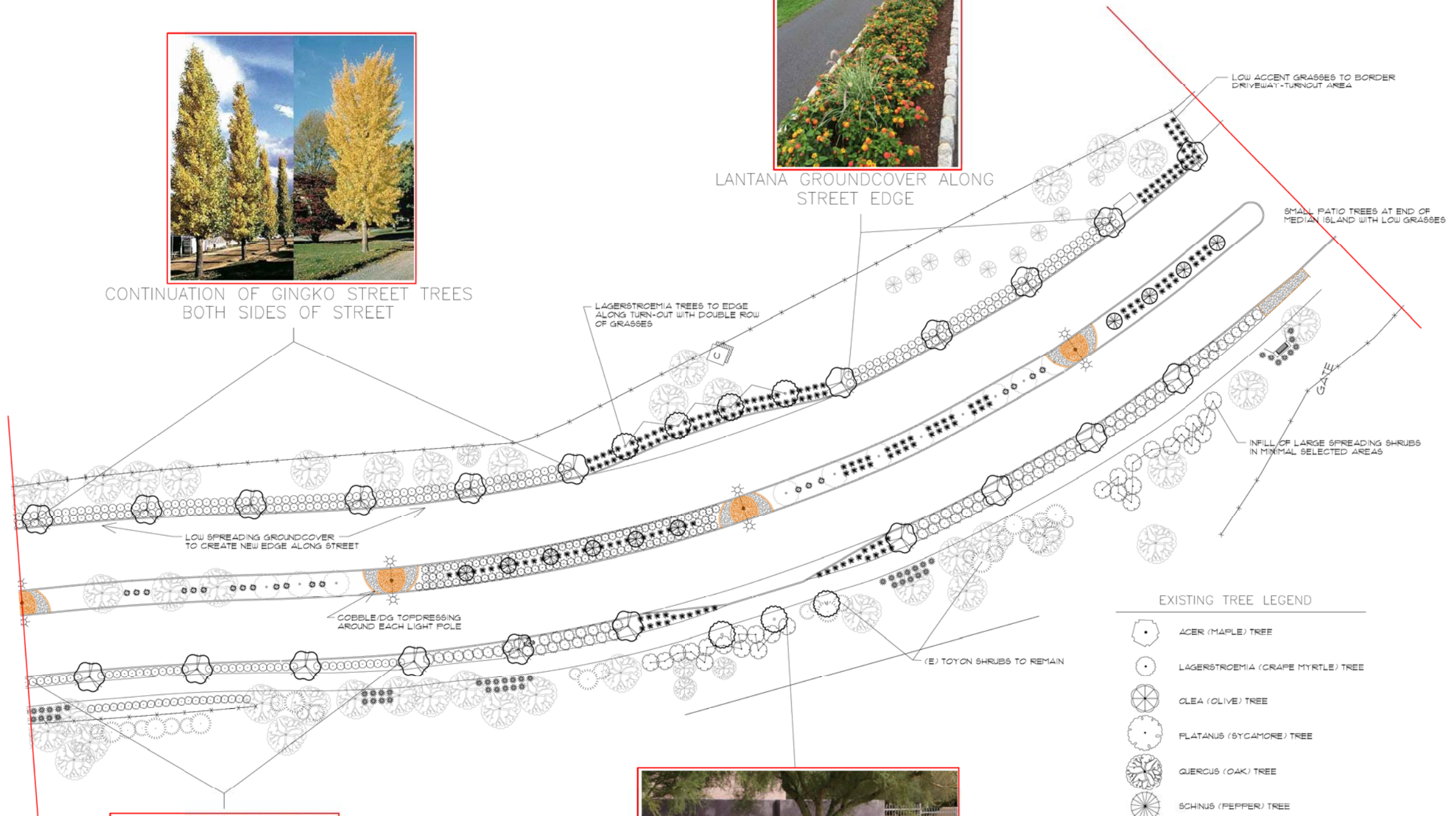







(E) ROW OF 'LITTLE JOHN' TO REMAIN



INFILL OF ACACIA SPREADING GROUNDCOVER

EXISTING TREE LEGEND

-  ACER (MAPLE) TREE
-  LAGERSTROEMIA (GRAPE MYRTLE) TREE
-  OLEA (OLIVE) TREE
-  PLATANUS (SYCAMORE) TREE
-  QUERCUS (OAK) TREE
-  SCHINUS (PEPPER) TREE
-  SEQUOIA (REDWOOD) TREE

NOTE: ALL EXISTING TREES SHOWN ARE TO REMAIN

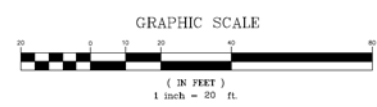

PARKWAY - SHEET 'D'  
HIDDENBROOKE ENTRY PARKWAY LANDSCAPE CONCEPT MASTER PLAN

SCALE: 1" = 20'-0"

NOTE:  
THIS IS AN ORIGINAL UNBIDDABLE  
DRAWING. ANY REVISIONS, CORRECTIONS,  
OR AMENDMENTS MUST BE MADE IN THE  
ORIGINAL. THE CONTRACTOR SHALL BE  
RESPONSIBLE FOR THE ACCURACY OF  
THE INFORMATION PROVIDED.  
DATE: 01/27/21

DATE	MARK



**BORRECCO/KILIAN & ASSOCIATES, INC.**  
LANDSCAPE ARCHITECTS  
1241 Pine Street  
Martinez, California 94553  
Phone: 925/372-5306



CITY OF VALLEJO  
HIDDENBROOKE VALLEJO  
PLANNING SOURCE - FY 2021  
**HIDDENBROOKE ENTRY PARKWAY**  
LANDSCAPE CONCEPT MASTER PLAN

DATE PROJECT #	< PROJ. NO. >
DESIGNED BY	B.K.
DRAWN BY	B.K.
CHECKED BY	B.K.
DATE	01/27/21
SCALE	1" = 80'-0"
SHEET	1
<b>L-5</b>	
OF 09 SHEETS	
DRAWING FILE #	
FILE NO.	

FILENAME.DWG - FULL ELECTRONIC PATH

DRAWING FILENAME - DWG





IN-FILL WITH SYCAMORE STREET TREES

REMOVE MISCELLANEOUS SHRUBS AND GROUNDCOVER ON SLOPES

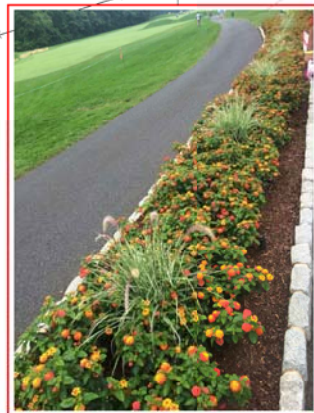
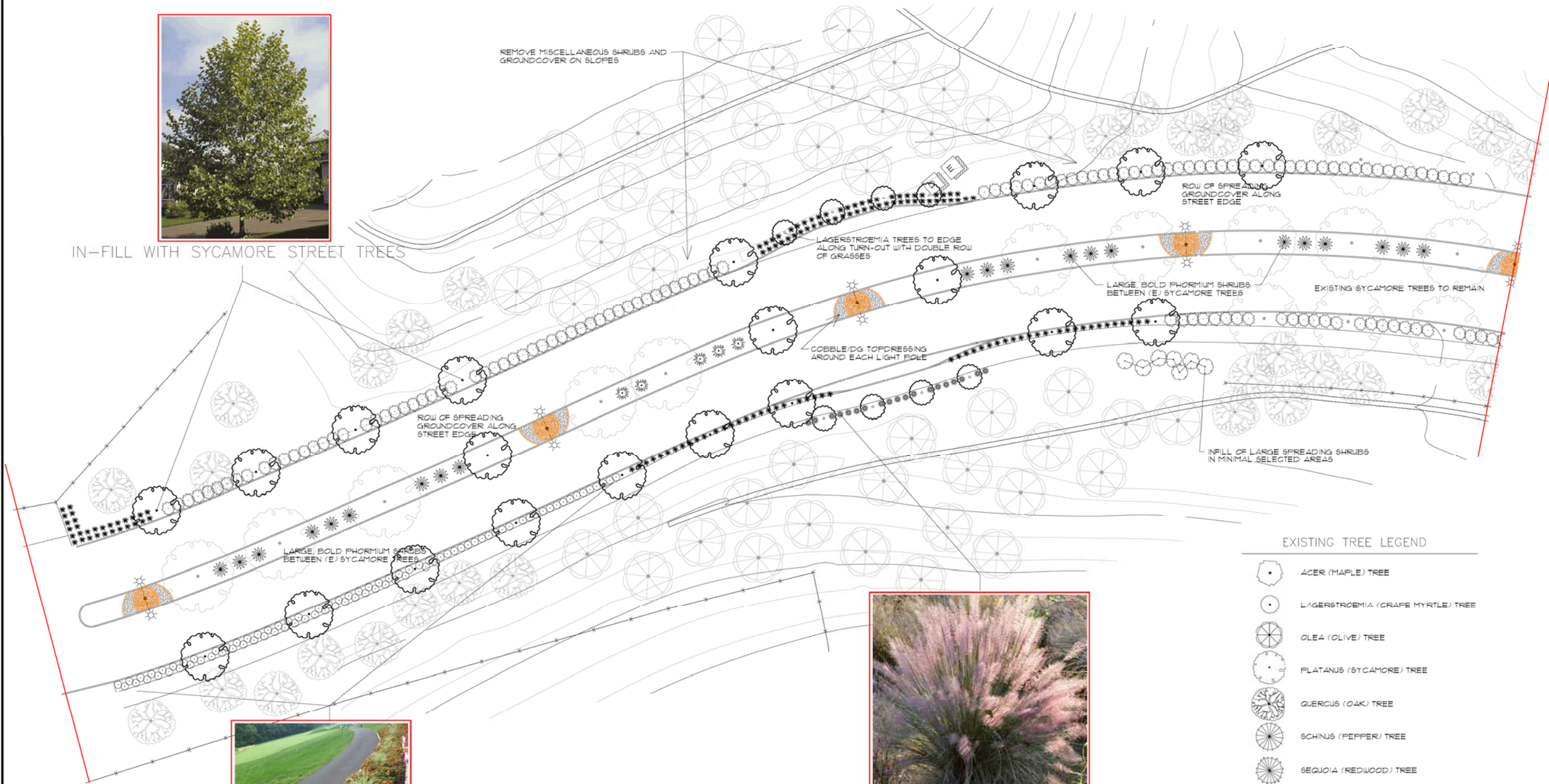

ROW OF LANTANA SHRUBS

(E) TOYON SHRUBS TO REMAIN

LOW SPREADING GROUNDCOVER TO CREATE NEW EDGE ALONG STREET



MUHLENBERGIA GRASS TO EDGE TURN-OUT AND PATHWAY

EXISTING TREE LEGEND

- ACER (MAPLE) TREE
- LAGERSTROEMIA (GRAPE MYRTLE) TREE
- OLEA (OLIVE) TREE
- PLATANUS (SYCAMORE) TREE
- QUERCUS (OAK) TREE
- SCHINUS (PEPPER) TREE
- SEQUOIA (REDWOOD) TREE

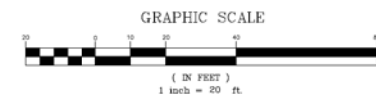

PARKWAY – SHEET 'E'  
HIDDENBROOKE ENTRY PARKWAY LANDSCAPE CONCEPT MASTER PLAN

SCALE: 1" = 20'-0"

NOTE:  
THIS IS AN OFFICIAL UNRECORDED COPY. PUBLISHED OR OTHERWISE COPIED WITHOUT THE WRITTEN CONSENT OF BIALI, INC.  
COPYRIGHT © BORRECO/KILIAN & ASSOCIATES, INC.

DATE	MARK	REVISION

BORRECO/KILIAN & ASSOCIATES, INC.  
LANDSCAPE ARCHITECTS  
1241 Pine Street  
Martinez, California 94553  
Phone: 925/972-5306

CITY OF VALLEJO  
HIDDENBROOKE VALLEJO  
← FUNDING SOURCE - FY2017A →  
**HIDDENBROOKE ENTRY PARKWAY**  
LANDSCAPE CONCEPT MASTER PLAN

CITY PROJECT #  
← PROJ. NO. →  
DESIGNED BY  
B.K.  
DRAWN BY  
B.K.  
CHECKED BY  
B.K.  
DATE  
03/29/21  
SCALE  
1" = 80'-0"  
SHEET 1  
**L-6**  
OF 15 SHEETS  
DRAWING FILE #  
FILE NO.

FILENAME.DWG - FULL ELECTRONIC PATH

← DRAWING FILENAME → DWG



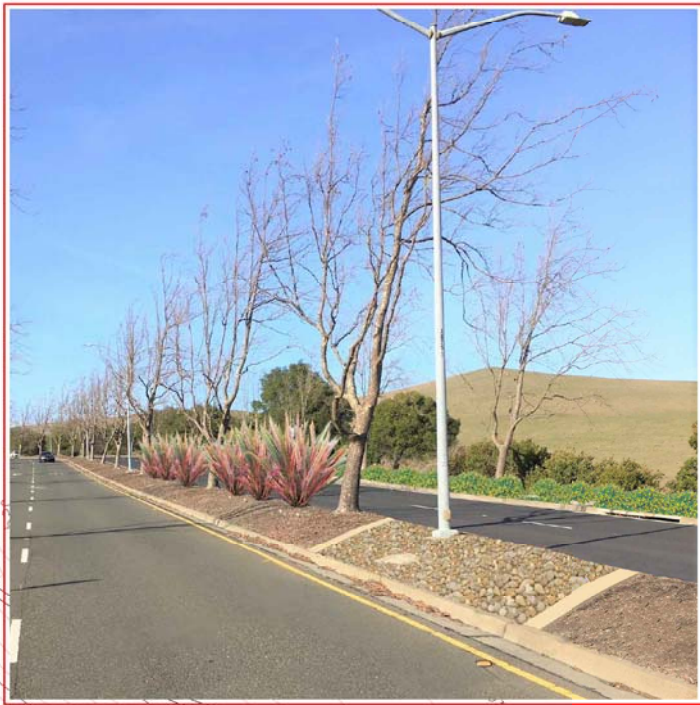
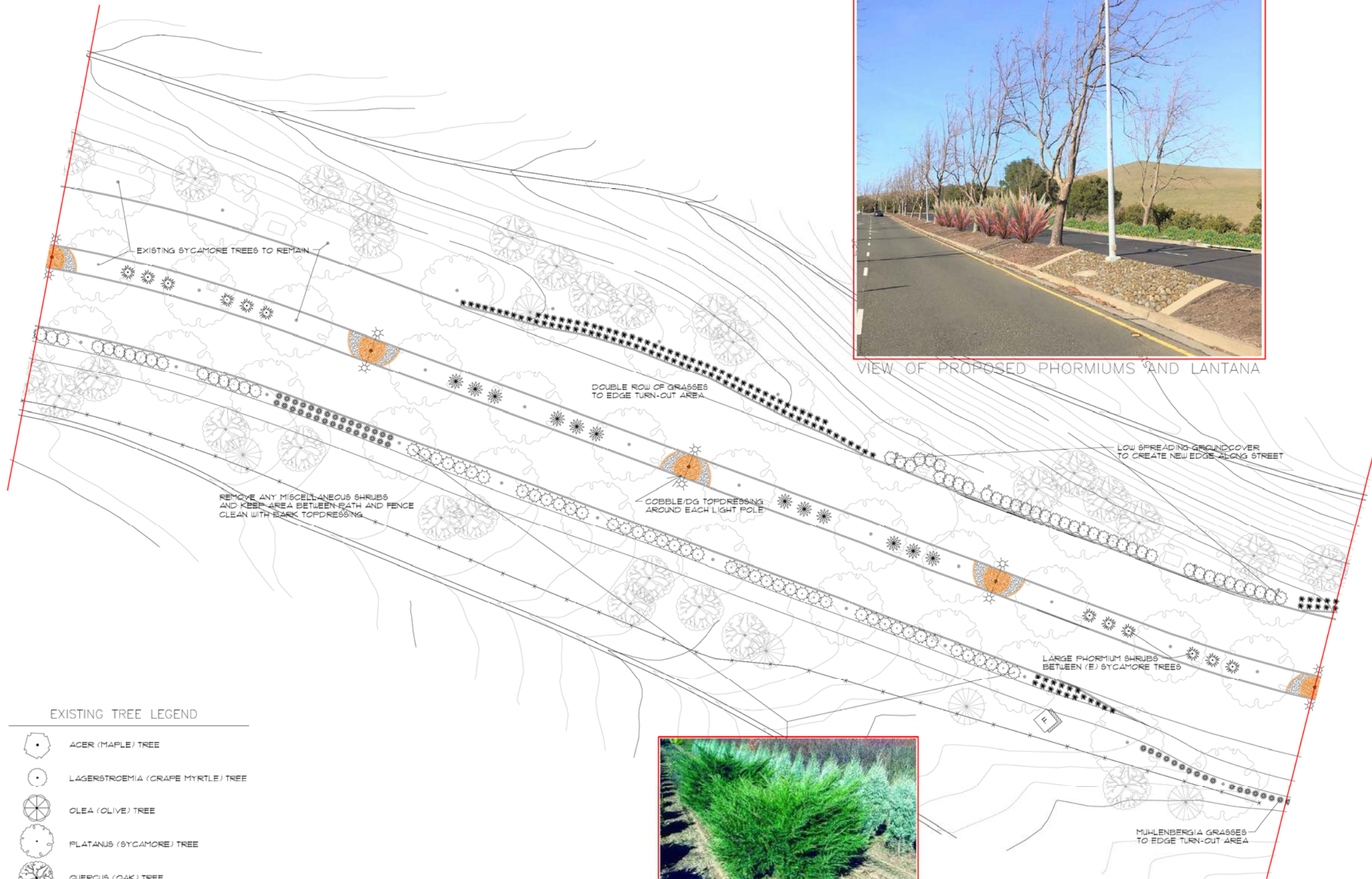







VIEW OF PROPOSED PHORMIUMS AND LANTANA



ROW OF VASE SHAPED JUNIPERS

EXISTING TREE LEGEND

-  ACER (MAPLE) TREE
-  LAGERSTROEMIA (CRAPE MYRTLE) TREE
-  OLEA (OLIVE) TREE
-  PLATANUS (SYCAMORE) TREE
-  QUERCUS (OAK) TREE
-  SCHINUS (PEPPER) TREE
-  SEQUOIA (REDWOOD) TREE

PARKWAY – SHEET 'F'

HIDDENBROOKE ENTRY PARKWAY LANDSCAPE CONCEPT MASTER PLAN

SCALE: 1" = 20'-0"

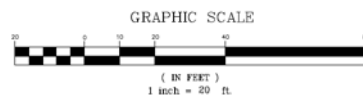

NOTE:  
THIS IS AN ORIGINAL UNRECORDED  
COPY, PUBLISHED OR OTHERWISE  
FOR THE UNITED STATES OF AMERICA  
COPYRIGHT © 2015 BY BORRECCO/KILIAN & ASSOCIATES, INC.

INT.	
DATE	
MARK	



**BORRECCO/KILIAN & ASSOCIATES, INC.**  
**LANDSCAPE ARCHITECTS**  
 1241 Pine Street  
 Martinez, California 94553  
 Phone: 925/972-5306



**HIDDENBROOKE ENTRY PARKWAY**  
 LANDSCAPE CONCEPT MASTER PLAN

CITY PROJECT #  
 < PROJ. NO. >  
 DESIGNED BY  
 B.K.  
 DRAWN BY  
 B.K.  
 CHECKED BY  
 B.K.  
 DATE  
 03/29/21  
 SCALE  
 1" = 80'-0"  
 SHEET 1  
**L-7**  
 OF 15 SHEETS  
 DRAWING FILE #  
 FILE NO.







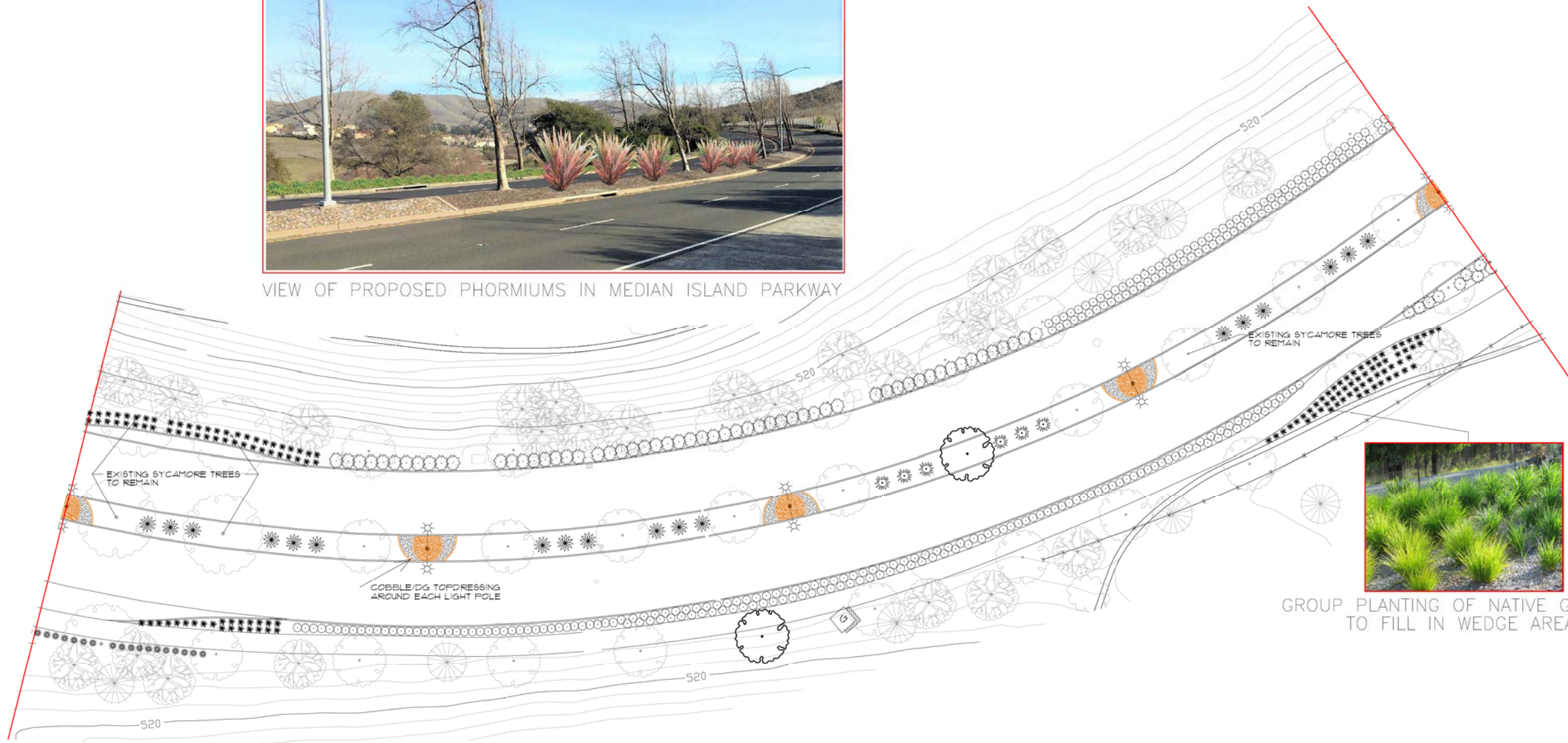



VIEW OF PROPOSED PHORMIUMS IN MEDIAN ISLAND PARKWAY



GROUP PLANTING OF NATIVE GRASSES TO FILL IN WEDGE AREA

EXISTING TREE LEGEND

-  ACER (MAPLE) TREE
-  LAGERSTROEMIA (CRAPE MYRTLE) TREE
-  OLEA (OLIVE) TREE
-  PLATANUS (SYCAMORE) TREE
-  QUERCUS (OAK) TREE
-  SCHINUS (PEPPER) TREE
-  SEQUOIA (REDWOOD) TREE

PARKWAY — SHEET 'G'  
**HIDDENBROOKE ENTRY PARKWAY LANDSCAPE CONCEPT MASTER PLAN**

SCALE: 1" = 20'-0"

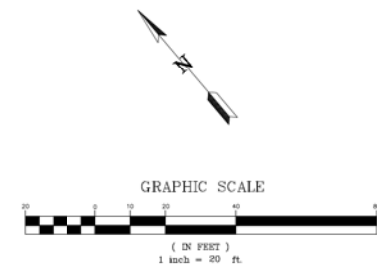

NOTE:  
 THIS IS AN OFFICIAL INSTRUMENT OF SERVICE.  
 WORK AND ANY NOT BE SCHEDULED,  
 COPIES, REPRODUCED, OR OTHERWISE  
 USED FOR ANY PURPOSE WITHOUT THE WRITTEN CONSENT  
 OF B&B.  
 COPYRIGHT © BORRECCO/KILIAN & ASSOCIATES, INC.

DATE	MARK	BY

**BORRECCO/KILIAN & ASSOCIATES, INC.**  
**LANDSCAPE ARCHITECTS**  
 1241 Pine Street  
 Martinez, California 94553  
 Phone: 925/372-5306

CITY OF VALLEJO  
 HIDDENBROOKE ENTRY PARKWAY  
 LANDSCAPE CONCEPT MASTER PLAN

CITY PROJECT #	< PROJ. NO. >
DESIGNED BY	B.K.
DRAWN BY	B.K.
CHECKED BY	B.K.
DATE	03/29/21
SCALE	1" = 20'-0"
SHEET	1
OF 15 SHEETS	
DRAWING FILE #	
FILE NO.	







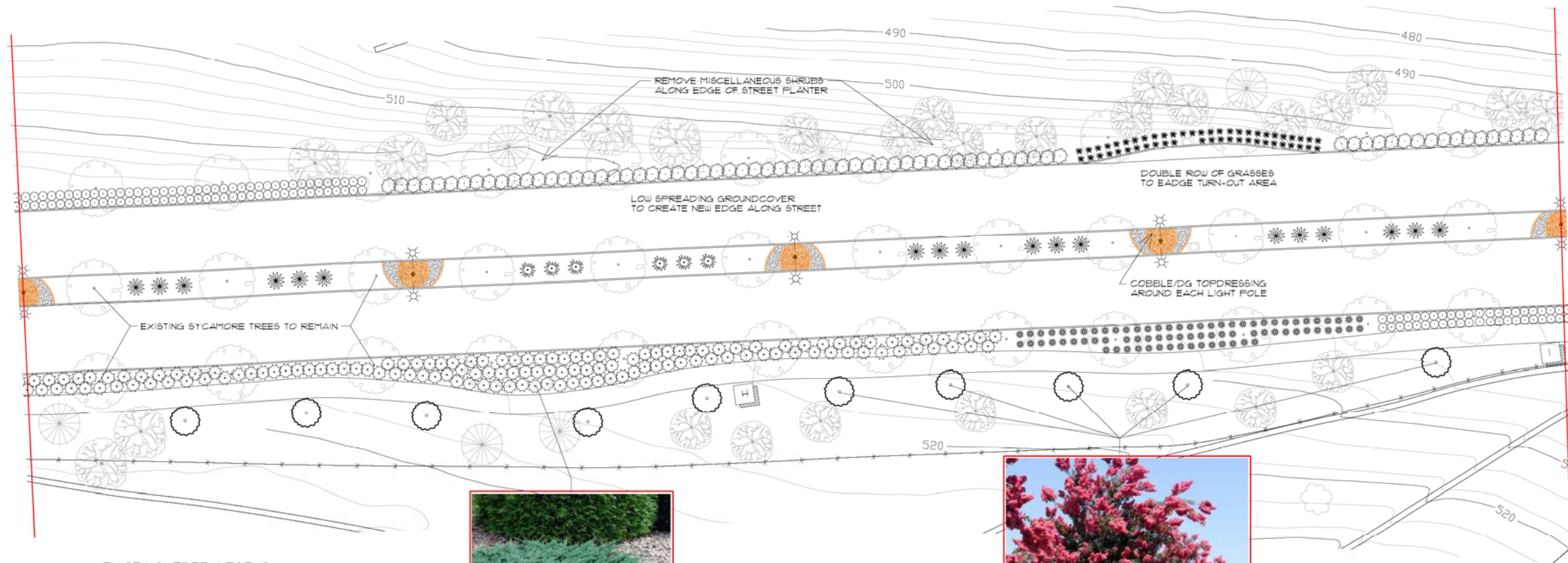



PROPOSED CENTER MEDIAN ISLAND ELEVATION



EXISTING TREE LEGEND

-  ACER (MAPLE) TREE
-  LAGERSTROEMIA (CRAPE MYRTLE) TREE
-  OLEA (OLIVE) TREE
-  PLATANUS (SYCAMORE) TREE
-  QUERCUS (OAK) TREE
-  SCHINUS (PEPPER) TREE
-  SEQUOIA (REDWOOD) TREE



LOW SPREADING JUNIPER GROUNDCOVER



ADD LAGERSTROEMIA TREES ALONG BACKSIDE OF PATHWAY

PARKWAY – SHEET 'H'

HIDDENBROOKE ENTRY PARKWAY LANDSCAPE CONCEPT MASTER PLAN

SCALE: 1" = 20'-0"

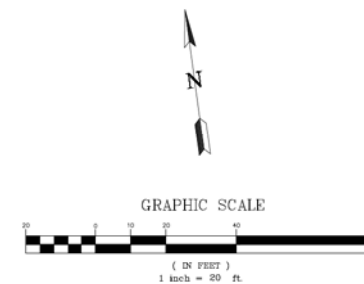

NOTE:  
THIS IS AN ORIGINAL UNREPRODUCED  
DRAWING. ANY COPIES, REPRODUCTIONS,  
OR ALTERATIONS WITHOUT THE WRITTEN CONSENT  
OF BORRECO/KILIAN & ASSOCIATES, INC.  
ARE STRICTLY PROHIBITED.

DATE	MARK	DESCRIPTION

**BORRECO/KILIAN & ASSOCIATES, INC.**  
LANDSCAPE ARCHITECTS  
1241 Pine Street  
Martinez, California 94553  
Phone: 925/972-5306

CITY OF VALLEJO  
HIDDENBROOKE VALLEJO  
< FUNDING SOURCE - FY 22 TAX >  
**HIDDENBROOKE ENTRY PARKWAY**  
LANDSCAPE CONCEPT MASTER PLAN

CITY PROJECT #  
< PROJ. NO. >  
DESIGNED BY  
B.K.  
DRAWN BY  
B.K.  
CHECKED BY  
B.K.  
DATE  
03/29/21  
SCALE  
1" = 80'-0"  
SHEET 1  
**L-9**  
OF 09 SHEETS  
DRAWING FILE #  
FILE NO.











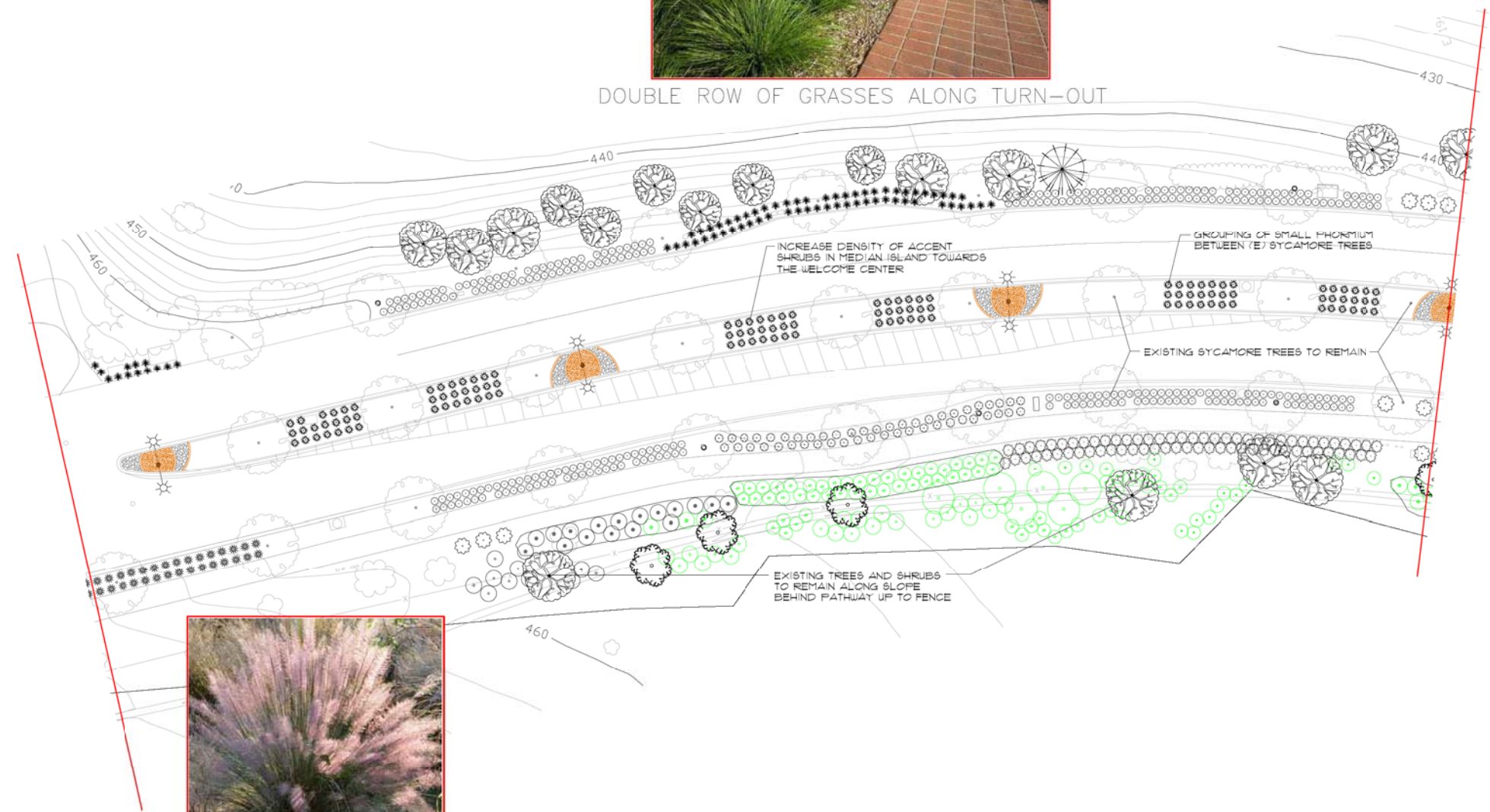





DOUBLE ROW OF GRASSES ALONG TURN-OUT



MUHLENBERGIA GRASSES AT INTERSECTION

EXISTING TREE LEGEND

-  ACER (MAPLE) TREE
-  LAGERSTROEMIA (CRAPE MYRTLE) TREE
-  OLEA (OLIVE) TREE
-  PLATANUS (SYCAMORE) TREE
-  QUERCUS (OAK) TREE
-  SCHINUS (PEPPER) TREE
-  SEQUOIA (REDWOOD) TREE

PARKWAY – SHEET 'J'

HIDDENBROOKE ENTRY PARKWAY LANDSCAPE CONCEPT MASTER PLAN

SCALE: 1" = 20'-0"

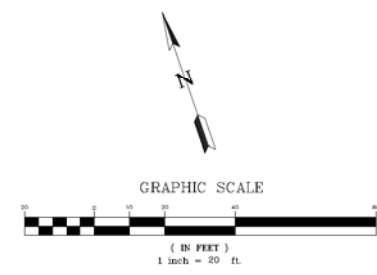

NOTE:  
THIS IS AN ORIGINAL UNPUBLISHED  
DRAWING. ANY REPRODUCTION,  
COPY, PUBLISHING OR OTHER  
USE WITHOUT THE WRITTEN CONSENT  
OF BKAA.

DATE	REVISION



**BORRECO/KILIAN & ASSOCIATES, INC.**  
**LANDSCAPE ARCHITECTS**  
 1241 Pine Street  
 Martinez, California 94553  
 Phone: 925/972-5306

CITY OF VALLEJO  
 HIDDENBROOKE VALLEJO  
 FUNDING SOURCE - FY XX / XX  
**HIDDENBROOKE ENTRY PARKWAY**  
 LANDSCAPE CONCEPT MASTER PLAN

CITY PROJECT #  
 < PROJ. NO. >  
 DESIGNED BY  
 B.K.  
 DRAWN BY  
 B.K.  
 CHECKED BY  
 B.K.  
 DATE  
 03/29/21  
 SCALE  
 1" = 80'-0"  
 SHEET 1  
**L-11**  
 OF 09 SHEETS  
 DRAWING FILE #  
**FILE NO.**







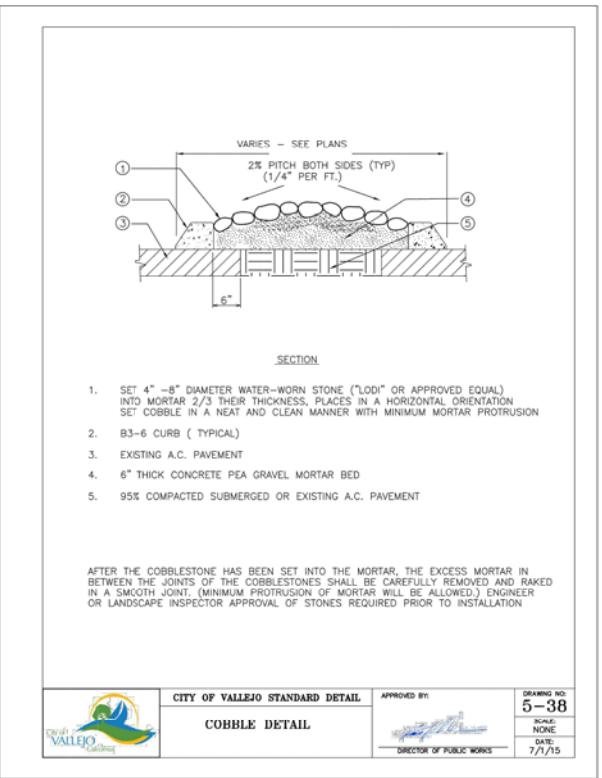
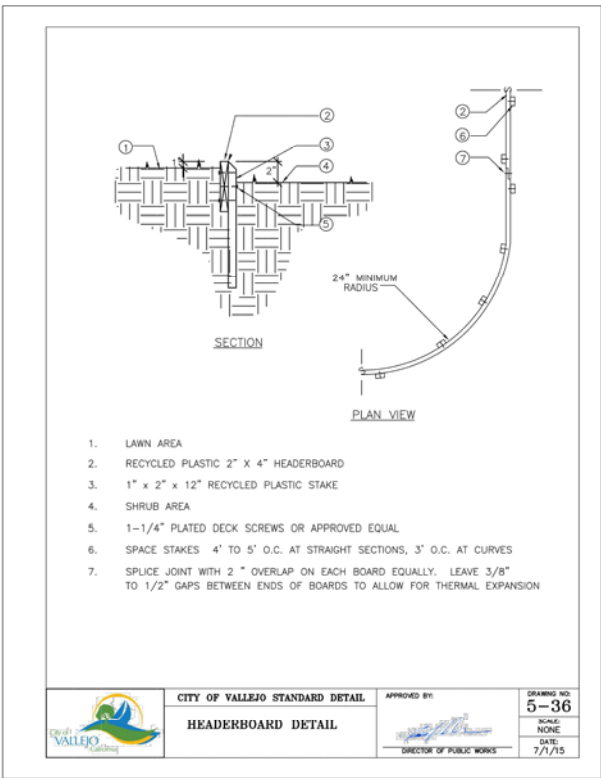
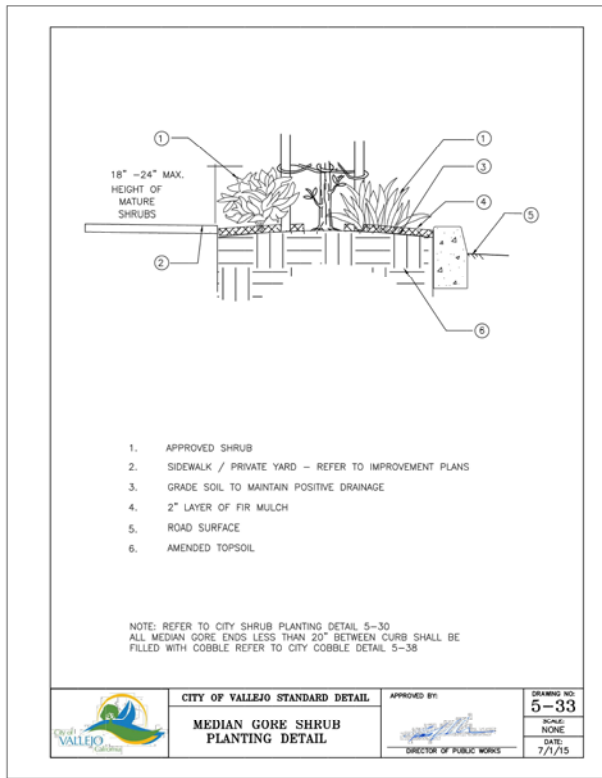
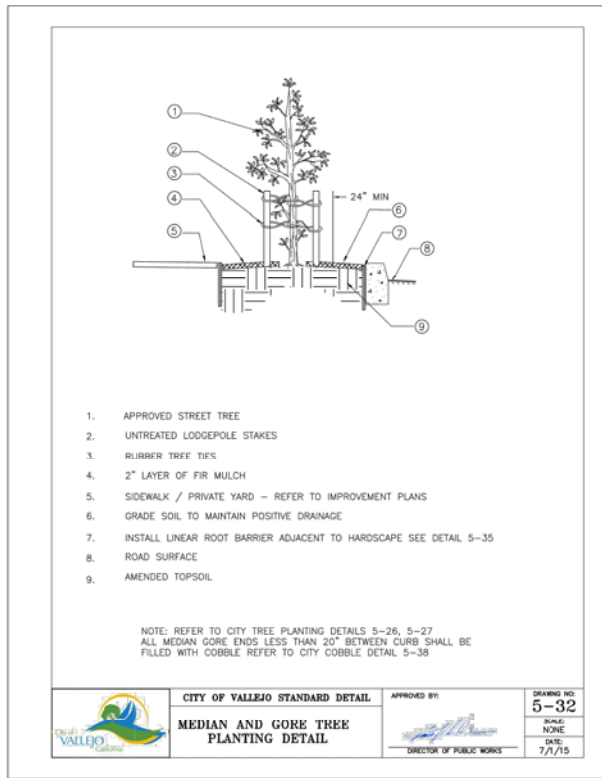
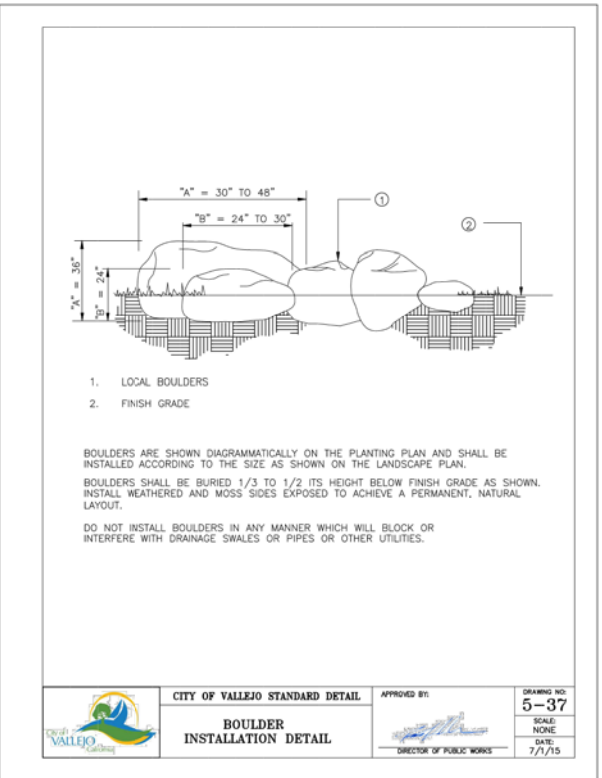
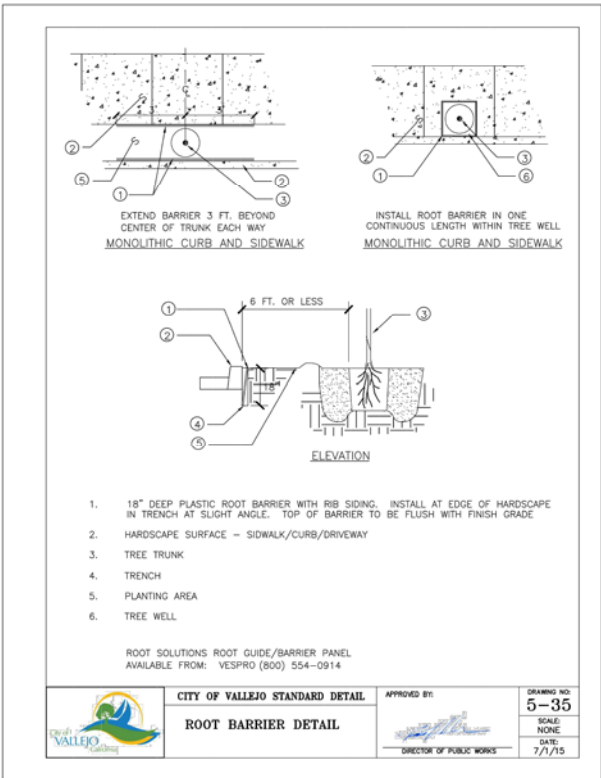
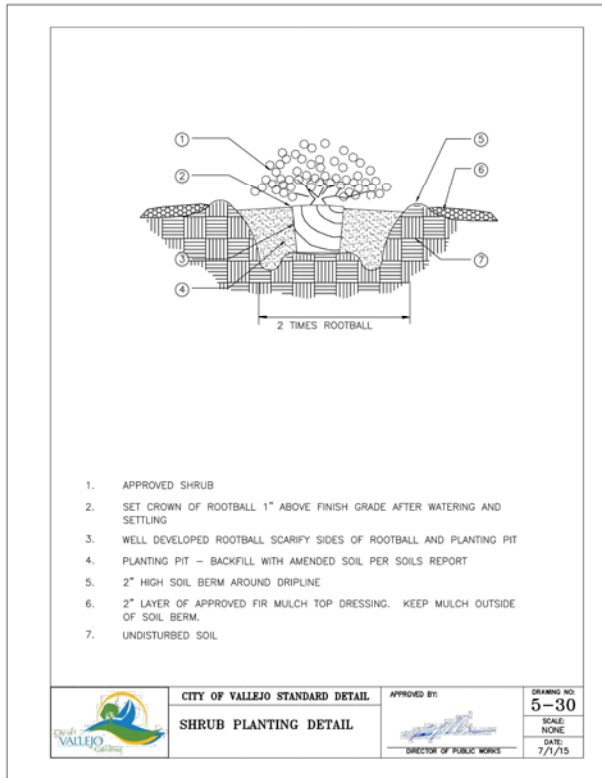
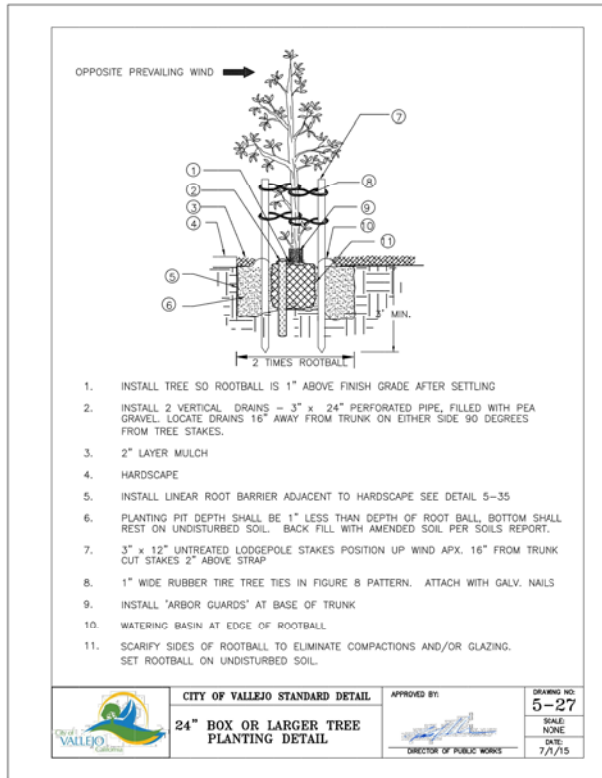

NOTE: THIS IS AN ORIGINAL UNPUBLISHED DRAWING. ANY REPRODUCTION OR COPIES, PUBLISHED OR OTHERWISE, WITHOUT THE WRITTEN CONSENT OF BBK ARE PROHIBITED.

CITY OF VALLEJO  
 HIDDENBROOKE VALLEJO  
 - FUNDING SOURCE - FY XX XXX ->  
**HIDDENBROOKE ENTRY PARKWAY**  
 LANDSCAPE CONCEPT MASTER PLAN

**BORRECCO/KILIAN & ASSOCIATES, INC.**  
**LANDSCAPE ARCHITECTS**  
 1241 Pine Street  
 Martinez, California 94553  
 Phone: 925/972-5306

CITY PROJECT # PW L001  
 DESIGNED BY B.K.  
 DRAWN BY B.K.  
 CHECKED BY B.K.  
 DATE 03/29/21  
 SCALE AS SHOWN  
 SHEET X  
**L-13**  
 OF 15 SHEETS  
 DRAWING FILE # FILE NO.

CITY OF VALLEJO LANDSCAPE DETAILS

< FILENAME.DWG - FULL ELECTRONIC PATH >

< DRAWING FILENAME > .DWG









LIVE OAK TREE



OLIVE TREE



ARBUTUS TREE



REDBUD TREE



ARBUTUS TREE



CRAPE MYRTLE TREE



CRAPE MYRTLE TREE



CALIFORNIA PEPPER TREE



SYCAMORE TREE



FLOWERING PLUM TREE



RHAPHIOLEPIS TREE STANDARD

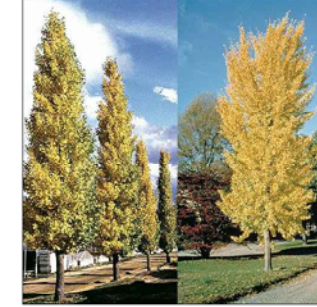

GINKGO TREE

EXISTING TREES ALONG HIDDENBROOKE PARKWAY

PROPOSED ADDITIONAL TREES ALONG HIDDENBROOKE PARKWAY



MAHONIA REPENS



JUNIPER HORIZONTALIS



LOMANDRA



TULBAGIA



LOMANDRA



STIPA FEATHER GRASS



PHORMIUM 'MONROVIA RED'



PHORMIUM 'APRICOT QUEEN'



PHORMIUM 'RADIANCE'



LATANIA 'GOLD RUSH'



BLUE OAT GRASS



DEER GRASS



LIRIOPE



COLEONEMA



JUNIPER 'MINT JULEP'



SMOKE TREE



COTONEASTER



CARPET ROSE



JUNIPER 'PLUMOSA'



VARIEGATED DIANELLA



CAREX GRASS

LARGE BOLD ACCENT SHRUBS

STREET EDGE PLANTING

GRASSES / ACCENT SHRUBS

NOTE: THIS IS AN ILLUSTRATION. WORK AND MAY NOT BE IDENTICAL. COVER, PUBLISHED OR UNPUBLISHED, WITHOUT THE WRITTEN CONSENT OF B.K.A. CONSULT A PROFESSIONAL LANDSCAPE ARCHITECT.

DATE	
SCALE	
SHEET	
FILE NO.	



**BORRECO/KILIAN & ASSOCIATES, INC.**  
**LANDSCAPE ARCHITECTS**  
 1241 Pine Street  
 Martinez, California 94553  
 Phone: 925/372-5306



CITY OF VALLEJO  
 HIDDENBROOKE VALLEJO  
 FUNDING SOURCE - FY 2017/18

**HIDDENBROOKE ENTRY PARKWAY**  
 LANDSCAPE CONCEPT MASTER PLAN

CITY PROJECT #	PW L001
DESIGNED BY	B.K.
DRAWN BY	B.K.
CHECKED BY	B.K.
DATE	03/29/21
SCALE	AS SHOWN
SHEET	X
<b>L-15</b>	
OF 15 SHEETS	
DRAWING FILE #	
FILE NO.	

FILENAME.DWG - FULL ELECTRONIC PATH

FILENAME.DWG - DWG